



Read this document carefully before using this device. The guarantee will be expired by device damages if you don't attend to the directions in the user manual. Also we don't accept any compensations for personal injury, material damage or capital disadvantages.

## ENDA ESC21 TOUCH BUTTON COOLING/ DEFROST CONTROL DEVICE

Thank you for choosing ENDA ESC21 temperature controllers.

- ▶ 77 x 33 x 41mm sized with touch buttons.
- ▶ 1 relay output for cooling or heating control.
- ▶ 1 NTC input and 1 digital input
- ▶ Ability to use digital input as 2nd NTC input.
- ▶ Offset value can be entered for NTC input
- ▶ Compressor, energy saving or door alarm control via digital input.
- ▶ Delay time and minimum operating time settings for compressor protection.
- ▶ Defrost duration and interval time settings.
- ▶ Time or evaporator temperature dependent or manual defrost feature
- ▶ Selectable smart defrost option.
- ▶ Upper and Lower setpoint value limits can be adjusted.
- ▶ Lower limit, upper limit and delay settings for alarm.
- ▶ Energy saving mode activation via digital input.
- ▶ Temperature unit can be selected °C or °F.
- ▶ CE marked according to EN standards.



**CE** **RoHS**  
**Compliant**

Order Code : ESC21

## CONNECTION DIAGRAM



ENDA ESC21 is intended for installation in control panels. Make sure that the device is used only for intended purpose. The electrical connections must be carried out by a qualified staff and must be according to the relevant locally applicable regulations. During an installation, all of the cables that are connected to the device must be free of electrical power. The device must be protected against inadmissible humidity, vibrations, severe soiling and make sure that the operation temperature is not exceeded. The cables should not be close to the power cables or components.

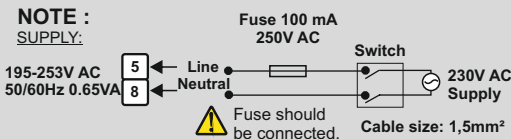
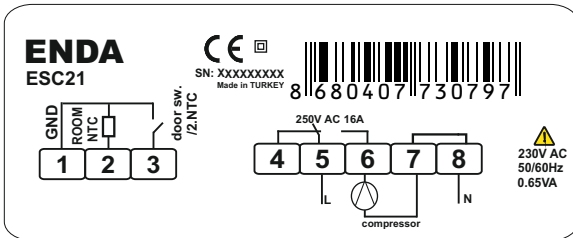

**Note:**  
1) Mains supply cords shall meet the requirements of IEC 60227 or IEC 60245.  
2) In accordance with the safety regulations, the power supply switch shall bring the identification of the relevant instrument and it should be easily accessible by the operator.

ENVIRONMENTAL CONDITIONS	
Ambient/Storage Temperature	0 ... +50°C/-25 ... 70°C (without icing)
Relative Humidity	80% Relative humidity for temperatures up to 31°C, decreasing linearly to 50% at 40°C.
Protection Class	According to EN 60529 : Front Panel : <b>IP65</b> , Rear Panel : <b>IP20</b>
Height	Max. 2000m
<b>⚠ KEEP AWAY device from exposed to corrosive, volatile and flammable gases or liquids and DO NOT USE the device in similar hazardous locations.</b>	
ELECTRICAL CHARACTERISTICS	
Supply Voltage	230V AC +%10 -%15, 50/60Hz
Power Consumption	Max. 0.65VA
Connection	2.5mm² screw-terminal connections
Line Resistance	Max. 100ohm
Data Protection	EEPROM (Min. 10 years)
Analog Inputs Measurement Field	NTC Resistive Sensor: -60 ...+99°C (-76 ... +302.0°F) range scale, ± 1% (full scale) ±1 digit accuracy, EN 60751
Time Accuracy	±%1sec.
Display	2 digit, 37mm 7 segment, with 7 function icon.
EMC	EN 61326-1: 2013
Safety Requirements	EN 61010-1: 2010 (Pollution degree 2, overvoltage category II).
OUTPUT	
Compressor Output	Resistive Load : NO 250V AC 16A, NC 250V AC 16A Inductive Load : 1/2hp 240V AC
Life expectancy for relay	Mechanical 30.000.000; Electrical 300.000 operation. 250V AC, 16A (resistive load)
CONTROL	
Control Format	Single set-point, door and alarm control
Control Type	On-Off control
A/D converter	12-bit accuracy, 100ms sampling time
Hysteresis	Adjustable between 0.1 and 20.0 °C
HOUSING	
Housing type	Suitable for flush-panel mounting(According to DIN 43 700).
Dimension	W77xH33xD41mm
Weight	90g (after packing)
Enclosure Material	Self extinguishing plastics
<b>⚠ Avoid any liquid contact when the device is switched on. DO NOT clean the device with solvent (thinner, gasoline, acid etc.) and / or abrasive cleaning agents.</b>	

## DIMENSIONS

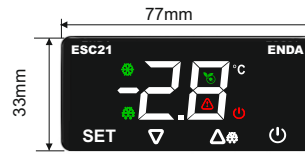

**To removing mounting clamps:**

- Push the flush-mounting clamp in direction 1 as shown in the figure below. Then, pull out the clamp in direction 2

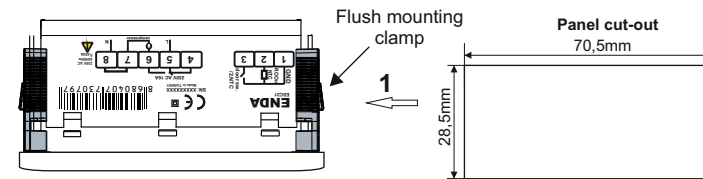
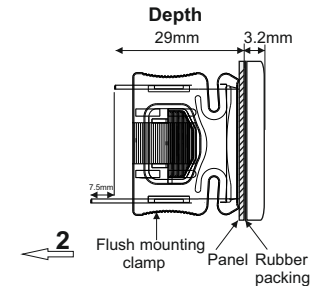

**Note :**  
1) Panel thickness should be maximum 7mm.  
2) If there is no 60mm free space at the back side of the device, it would be difficult to remove it from the panel.



SİSEL MÜHENDİSLİK ELEKTRONİK SAN. VE TİC. A.Ş.  
Şerifali Mah. Barbaros Cad. No:18 Y.Dudullu 34775  
UMRANIYE/İSTANBUL-TURKEY  
Tel : +90 216 499 46 64 Pbx. Fax : +90 216 365 74 01  
url : www.enda.com.tr



ESC21-EN-03-240105

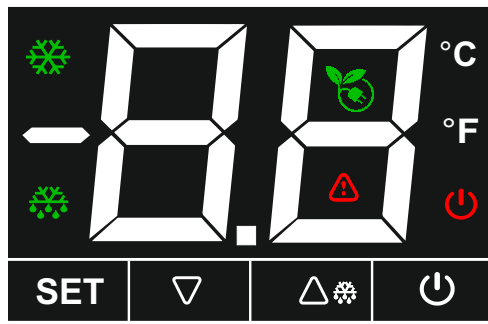

## LED/KEY DESCRIPTIONS

The Main Screen is called as "Running Mode"

LED	Description	KEY	Description
	<b>ON / OFF LED</b> -If the LED is on when device is turned "OFF"	<b>SET</b>	<b>Set Key</b> -In "Running Mode", it shows the set value, -In "Programming Mode", displays the value of the selected parameter and confirms the changed parameter value.
	<b>Compressor LED</b> -If the LED is on compressor is running, If the LED is flashing while the compressor protection will be in progress.		<b>Up Key</b> -In "Running Mode", manual defrost start if conditions are suitable -In "Programming Mode", switching between parameters and increase the value of the selected parameter.
	<b>Defrost LED</b> -If the LED is on defrost in progress, If the LED is flashing, dripping will be in progress.		<b>Down Key</b> -In "Running Mode", it shows the evaporator temperature(P4=1) -In "Programming Mode", switching between parameters and decrease the value of the selected parameter.
°C	<b>Celcius LED</b> -If the LED is on the unit of measurement for temperature is °C (Celcius) degrees..		<b>ON/OFF Key</b> -In "Running Mode", Turning OFF/ON the device -In "Programming Mode", returns to "Running Mode" .
°F	<b>Fahrenheit LED</b> -If the LED is on, the unit of measurement for temperature is °F (Fahrenheit) degrees.		
	<b>Energy Saving LED</b> -If the LED is on, the energy saving function is in progress.		
	<b>Warning LED</b> -If the LED is flashing, alarm and failure functions are in progress.		

### 1. Viewing and Changing the Set Value

→ **SET** → → → → → →

If the **SET** key is pressed for 2 seconds in "Running Mode", set value is displayed for 3 seconds. While in this case, the set value is changed with keys.

### 2. Viewing Defrost Probe Measurement Value

→ →

In "Running Mode", if 2nd input type selected as Analog Input (P4=1), pressing key for 5 seconds display shows the measured value of the defrost probe.

### 3. Locking and Unlocking Keys

→ **SET** + → Keys are locked.

If **SET** keys are pressed together for 3 seconds or no key is pressed for 1 minute in "Running Mode", **Lc** message will be displayed and keys will be locked.

If the keys are locked and any key is pressed for 2 seconds in "Running Mode" **uL** message will be displayed and keys will be unlocked.

### 4. Manual Defrost

If the key is pressed for 4 seconds in the "Running Mode", the defrost process is started or stopped manually.

- 1-If parameter **d3=0**, manual defrost is also disabled.
- 2 - If the 2nd input type is selected as analog input (P4= 1), defrost will not start if the measured value of the defrost probe is greater than the value in the **d2** parameter.

### 5. Manual Turning ON / OFF The Device

If the key is pressed for 3 seconds in the "Running Mode" (without the key lock), the display turns off, temperature measurement and control are not performed, the output becomes passive. If the key is pressed again for 3 seconds, the display turns on and the device continues to measure and control the temperature.

### 6. Factory Settings

If PS parameter is selected 1 Security Parameter **PR** is set to **-44** and the **SET** button is pressed, the **dF** message will appear on the display. If the **SET** button is pressed again while **dF** message is displayed, " --- " message will flash on the screen for 4 seconds, then the device will return to factory settings and return to "Running Mode".

If PS parameter is selected 0 if first **SET** and then keys are pressed together for 5 second in "Running Mode" **dF** message will appear on the display, then the device will return to factory settings and return to "Running Mode".

### 7. Viewing Revision Date

→ **SET** + → YY/MM/DD If the **SET** keys are pressed together in "Running Mode", revision date will be displayed as YY/MM/DD.

## 7. Changing Parameter Values

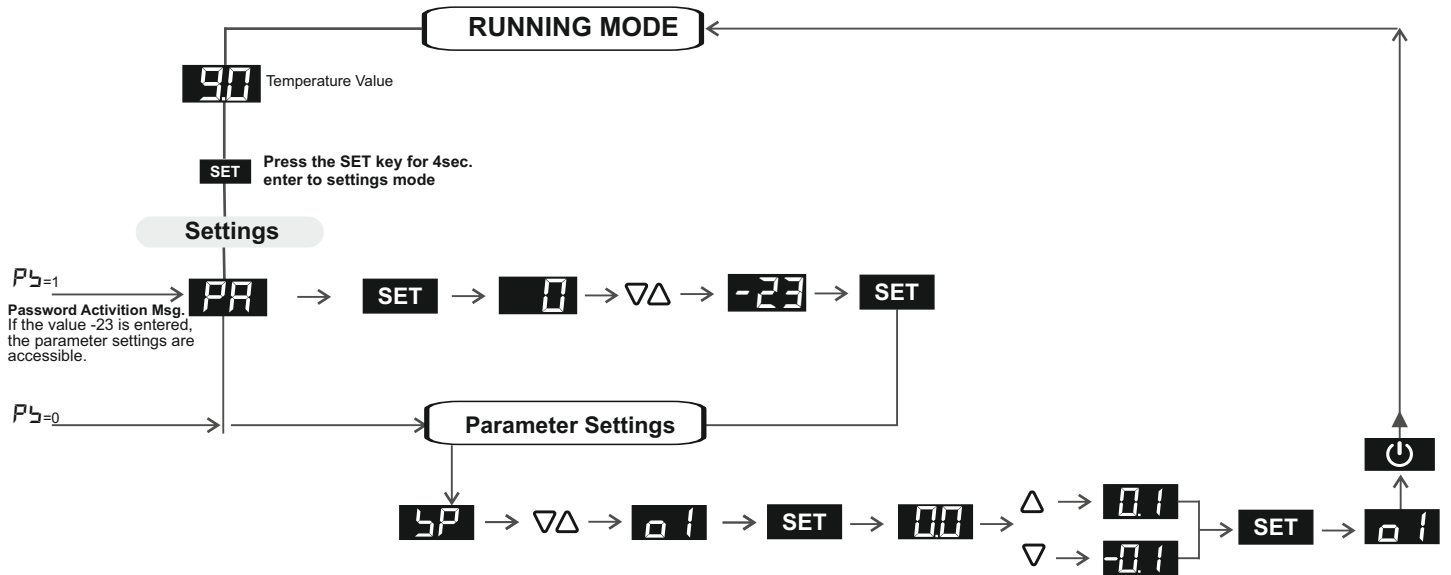

If the **SET** button is pressed for 4 seconds in the Running Mode, the password (*PR*) message is displayed on the display. By pressing the **SET** button, the password is set to “-23” with the  $\Delta$ / $\nabla$  keys and the **SET** is pressed, then the parameter menu is entered. By scrolling through the menu with the  $\Delta$ / $\nabla$  keys, when the desired parameter setting message is displayed, if the **SET** key is pressed, the value of that parameter is displayed. The value of the relevant parameter can be changed with the  $\Delta$ / $\nabla$  keys. If no operation is performed while the parameter value is displayed, after 3 seconds, or if the **SET** key is pressed again, the name of the parameter is returned. If the **SET** key is pressed while the parameter name is displayed, this time will be exited without waiting.

### Failure - Alarm - Info Messages Definitions

Display	Content	Display	Content
<b>Pb</b>	<b>Cabin Probe failure</b> -Check the sensor connection. -Compressor works according to $E4$ and $E5$ parameters.	<b>Lc</b>	<b>Key Locked Message</b> -To change the keylock settings, see: Keylock Operations.
<b>Pd</b>	<b>Defrost Probe Failure</b> -Check the sensor connection. -if $P4=1$ , defrost will not work.	<b>uL</b>	<b>Key Unlocked Message</b> -To change the keylock settings, see: Keylock Operations.
<b>AL</b>	<b>Low Temperature Alarm</b> -Check $R0, R1, R2$ parameters.	<b>--</b>	<b>Factory Reset Message</b> The device starts to work according to the factory settings.
<b>AH</b>	<b>High Temperature Alarm</b> -Check $R0, R4, R5$ parameters.	<b>df</b>	<b>Defrost Message</b> -Defrost is in progress. -Check $d5$ parameter.
<b>id</b>	<b>Door Alarm</b> -Check digital input. -Check $i0, i1, i2$ parameters.		
<b>iA</b>	<b>Multifunctional Digital Input alarm</b> -Check digital input. -Check $i0, i1$ parameters.		

## PARAMETERS LIST

### CONFIGURATION PARAMETERS

PAR.	PARAMETERS DESCRIPTION	UNIT	MIN.	MAX.	DEF.
5P	System control set point value.	°C/°F	r1	r2	4
o1	Cabin probe offset value.	°C/°F	-25	25	0
o2	Evaporator probe offset value (If P4 = 1).	°C/°F	-25	25	0
P1	Decimal Point Selection. 0 : Without decimal 1 : With decimal		0	1	1
P2	Temperature Unit. 0 : °C 1 : °F		0	1	0
P4	Second Input Type 0 : Digital input(door input) 1 : Analog input(evaporator probe)		0	1	0
P8	Temperature value refresh time to be shown on the display.	ds	0	99	5
Ps	Password activation selection for entering the parameter menu. 0: Password is <b>not</b> required when entering the menu.. 1: Password is required when entering the menu.		0	1	1

### MAIN CONTROL PARAMETERS

PAR.	PARAMETER DESCRIPTION	UNIT	MIN.	MAX.	DEF.
r0	System control set point hysteresis.	°C/°F	0	30	2
r1	The lower limit of the setpoint.	°C/°F	-60	r2	-40
r2	The upper limit of the set point.	°C/°F	r1	99	50
r4	Working set point increase during the "energy saving mode;" (See also i0 ,l1 )	°C/°F	0	99	0
r5	Cooling or heating option. 0: Cooling(Defrost active) 1: Heating(Defrost <b>not</b> active)		0	1	0

### COMPRESSOR PARAMETERS

PAR.	PARAMETER DESCRIPTION	UNIT	MIN.	MAX.	DEF.
C0	Delay time for the compressor after power is on.	min	0	99	0
C2	Minimum compressor switch-off duration.	min	0	99	3
C3	Minimum duration of compressor switch on time.	sec	0	99	0
C4	Compressor off time during probe failure.	min	0	99	0
C5	Compressor on time during probe failure.	min	0	99	0

### DEFROST PARAMETERS

DEF.	PARAMETER DESCRIPTION	UNIT	MIN.	MAX.	DEF.
d0	Automatic defrost interval. (if d0=0 defrost will not start)	hr	0	99	8
d2	If the evaporator temperature is greater than this value, defrost will not work.. (P4 must equal 1)	°C/°F	-60	99	25
d3	Defrost duration.	min	0	99	30
d4	Defrost begins with energy. 0 : Defrost doesn't start when the energy comes. 1 : Defrost starts when the energy comes.		0	1	0
d5	Delay time for defrost after power is on.	min	0	99	0
d6	During defrost display configuration. 0 : Cabin temperature is displayed 1 : If the cabin temperature is lower than "SP+r0", "SP+r0" is displayed, otherwise cabin temperature is displayed. 2 : During defrost, "dF" flashes on the screen.		0	2	1
d7	Dripping time (During drip time Compressor and Defrost will not work)	min	0	99	0
d8	Defrost activation type(Smart Defrost) 0 : The time counter (d0) between two defrosts is decremented regardless of any condition. 1 : The time counter (d0) between two defrosts is decremented only compressor is running.		0	1	0

DIGITAL INPUT PARAMETERS					
PAR.	PARAMETER DESCRIPTION	UNIT	MIN.	MAX.	DEF.
i0	Digital Input Option <b>0</b> : No action. <b>1</b> : <b>Door is open</b> :Compressor's stop until the door closes and (id ) flashes on the screen. <b>2</b> : <b>Energy saving mode</b> . <b>3</b> : <b>External Alarm</b> : The device continues to operate normally ia flashes on the display. <b>4</b> : <b>Serious Alarm</b> : Compressor stops andia flashes on the display.		0	4	0
i1	Type of digital input contact. <b>0</b> : Normally open(acvite input with closed contact). <b>1</b> : Normally closed(active input with open contact).		0	1	0
i2	Door is open("id ") display delay time	min	0	99	30
i3	Digital input delay time.	min	0	99	15
ALARM PARAMETERS					
PAR.	PARAMETER DESCRIPTION	UNIT	MIN.	MAX.	DEF.
A0	High / Low temperatue alarm (AL, AH) hysteresis value.	°C/°F	0	20	2
A1	Low temperature alarm set point.	°C/°F	-99	99	10
A2	Low temperature alarm (AL) type. <b>0</b> : No alarm. <b>1</b> : Alarm set value equals to "SP- A1 " <b>2</b> : Alarm set value equals to A1		0	2	1
A4	High temperature alarm (AH) set point.	°C/°F	-99	99	30
A5	High temperature alarm (AH) type <b>0</b> : No alarm <b>1</b> : Alarm set value equals to "SP+A4" <b>2</b> : Alarm set value equals to A4		0	2	1
A6	High temperature alarm message delay time after power is on.	min	0	99	12
A7	Time delay to display alarm message after alarm is on.	min	0	99	15
A8	High temperature alarm delay time after defrost.	min	0	99	5