



Please read this document carefully before using this product. The guarantee will be invalidated if the device is damaged by not following instructions detailed in the manual. The company shall not be responsible for any damage or losses however caused, which may be experienced as a result of the installation or use of this product.

ENDA ET1412 DIGITAL THERMOSTAT

Thank you for choosing ENDA ET1412 temperature controller.

- * 35 x 77mm sized.
- * On-Off output.
- * Contact output for alarm.
- * Single contact output for selectable heating or cooling control.
- * Single NTC probe input..
- * Offset value can be entered for NTC probe.
- * In the case of probe failure, output state can be selected on, off or periodical running.
- * Upper and lower limits of the set point can be adjusted.
- * Selectable independent, deviation or band alarm.
- * Temperature unit can be selected °C or °F.
- * CE marked according to European Norms.



Order Code : ET1412-NTC-□□□□□□

Supply Voltage
230VAC.....230V AC
24.....24V AC/DC
12.....12V AC/DC

Connection Diagram



ENDA ET1412 is intended for installation in control panels. Make sure that the device is used only for intended purpose. The electrical connections must be carried out by a qualified staff and must be according to the relevant locally applicable regulations. During an installation, all of the cables that are connected to the device must be free of electrical power. The device must be protected against inadmissible humidity, vibrations, severe soiling and make sure that the operation temperature is not exceeded. The cables should not be close to the power cables or components.

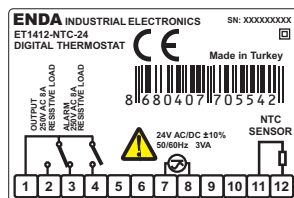
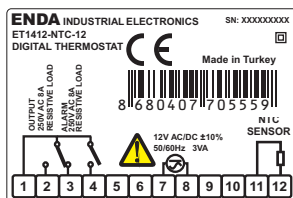
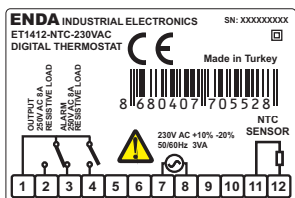

Equipment is protected throughout by DOUBLE INSULATION

Holding screw 0.4-0.5Nm.

NOTE:



- Note:**
- 1) Mains supply cords shall meet the requirements of IEC 60227 or IEC 60245.
 - 2) In accordance with the safety regulations, the power supply switch shall bring the identification of the relevant instrument and it should be easily accessible by the operator.

Technical Specifications

ENVIRONMENTAL CONDITIONS	
Ambient/storage temperature	0 ... +50°C/-25 ... +70°C (with no icing)
Max. relative humidity	80%, up to 31°C decreasing linearly 50% at 40°C
Rated pollution degree	According to EN 60529 Front panel : Ip65 Rare panel : IP20
Height	Maximum 2000m
Do not use the device in locations subject to corrosive and flammable gasses.	

ELECTRICAL CHARACTERISTICS	
Supply voltage	230V AC +10% -20%, 50/60Hz or 12/24V AC/DC ±10%, 50/60Hz.
Power consumption	Max. 3VA
Wiring	2.5mm ² screw-terminal connections.
Scale	-60.0 ... +150.0°C (-76.0 ... +302.0°F)
Sensitivity/Accuracy	0.1°C / ±1°C
Time Accuracy	(±1%-1sec)
Indicator	4 digits, 12.5mm, 7 segment yellow LED
EMC	EN 61326-1: 1997, A1: 1998, A2: 2001 (Performance criterion B is satisfied for EMC tests. The device is designed to operate in controlled electromagnetic environment)
Safety requirements	EN 61010-1: 2001 (Pollution degree 2, overvoltage category II)

OUTPUTS	
Output	Relay: 250V AC, 8A (for resistive load), NO+NC; 1/2 HP 240V AC Cosφ = 0.4 (for inductive load)
Alarm	Relay: 250V AC, 8A (for resistive load), NO+NC; 1/2 HP 240V AC Cosφ = 0.4 (for inductive load)
Life expectancy for relay	Mechanical 30.000.000; Electrical 100.000 operation.

CONTROL	
Control type	Single-setpoint control
Control algorithm	On-Off control
Hysteresis	Adjustable between 0.1 ... 20.0°C.

HOUSING	
Housing type	Suitable for flush-panel mounting.
Dimensions	W77xH35xD71mm
Weight	Approx. 215g (After packing)
Enclosure material	Self extinguishing plastics
While cleaning the device, solvents (thinner, benzene, acid etc.) or corrosive materials must not be used.	

Dimensions



For removing mounting clamps:

Push the flush-mounting clamp in direction 1 as shown in the figure below. Then, pull out the clamp in direction 2.

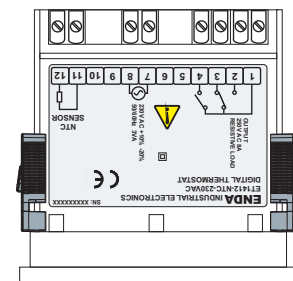
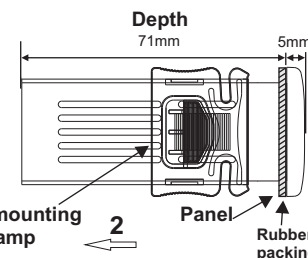

Flush mounting clamp

Panel cut-out

- Note : 1) Panel thickness should be maximum 7 mm.
2) If there is no 60mm free space at the back side of the device, it

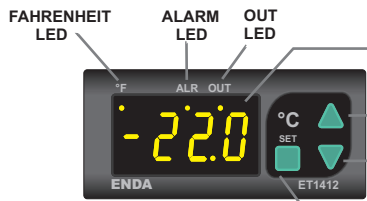

Displayed process value in the run mode, parameter name or value in programming mode.

Used for selecting menu and increasing setpoint value of the parameters in the programming mode and for increasing the setpoint value in the run mode. When held down for a few seconds, the change rate accelerates.

Used for selecting parameters and decreasing the setpoint value in the programming mode and for decreasing the setpoint value in the run mode. When held down for a few seconds, the change rate accelerates.

Used for adjusting the value of the setpoint in the run mode and for adjusting the selected parameter in the programming mode. While holding **SET** key, setpoint value of the selected parameter appears and by using **▲** and **▼** keys the value can be adjusted.

Run Mode

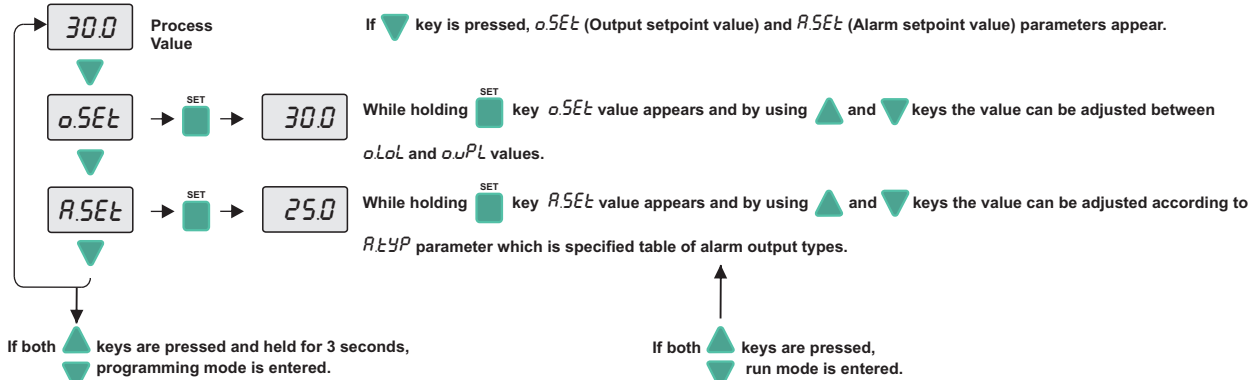

Programming Mode

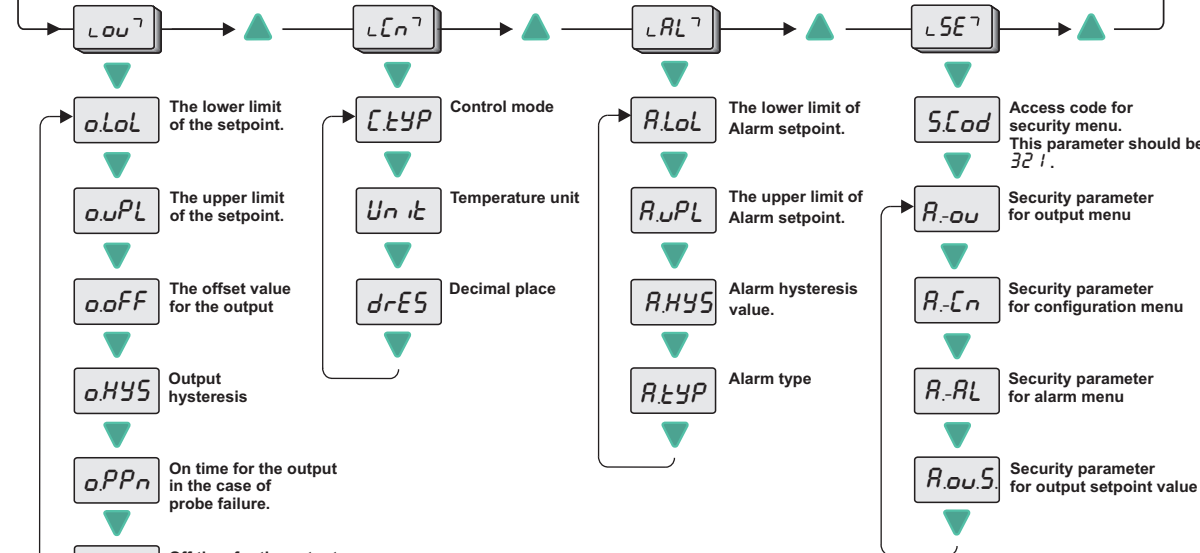

Error Messages

PSC	Means, thermostat probe is short circuit.	----	Temperature value is higher than the scale.
PFR	Means, thermostat probe is broken.	----	Temperature value is lower than the scale.

PARAMETER TABLE				
LOU Menu of Output control parameters				
<i>oLoL</i>	The lower limit of the setpoint	MIN	MAX	UNIT
		-60.0	<i>oUpL</i>	°C
<i>oUpL</i>	The upper limit of the setpoint		150.0	°C
<i>oOFF</i>	The offset value for the output	-20.0	20.0	°C
<i>oHYS</i>	Output hysteresis	1.0	20.0	°C
<i>oPPn</i>	On time for the output in the case of probe failure.	0	255	Min.
<i>oPPF</i>	Off time for the output in the case of probe failure.	0	255	Min.
LCN Menu of Configuration				
<i>CLYP</i>	Control mode (HEAT = Heating control, COOL = Cooling control.)	HEAT	COOL	HEAT
<i>Unit</i>	Temperature unit.	°C	°F	°C
<i>drES</i>	Decimal place (no = no decimal point, YES = with decimal point.)	no	YES	no
LAL Menu of Alarm control parameters				
<i>ALoL</i>	The lower limit of Alarm setpoint.	(**)	<i>AUpL</i>	°C
			(**)	°C
<i>AUpL</i>	The upper limit of Alarm setpoint.			150
<i>AHYS</i>	Alarm hysteresis value.(*)	0.1	20.0	°C
<i>RtYP</i>	Alarm type.	<i>inAL</i>	<i>boAL</i>	<i>inAL</i>
LSE Menu of Parameter security				
<i>R-ou</i>	Security parameter for menu of output control	<i>nonE</i> = Menu is invisible.		
<i>R-cn</i>	Security parameter for menu of configuration	<i>PYES</i> = Parameters of menu are changeable.		
<i>R-AL</i>	Security parameter for menu of alarm	<i>Pno</i> = Parameters of menu are only visible.		
<i>R-ouS</i>	Security parameter for output setpoint value	<i>PYES</i> = Setpoint value is changeable.		
		<i>Pno</i> = Setpoint value is only visible.		

(*) If one of the band alarm types are selected, alarm hysteresis value should not be greater than alarm set value.
 (**) Min. value of *ALoL* parameter and max. value of *AUpL* parameter are at the alarm types diagram.

Alarm Output Types

